

N-Channel Enhancement Mode Power MOSFET

MAIN CHARACTERISTICS

I_D	8A
V_{DSS}	650V
$R_{DS(on)-typ}$ (@ $V_{GS}=10V$)	1.1 Ω

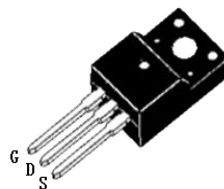
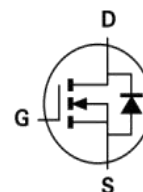

TO-220F/SL8N65F

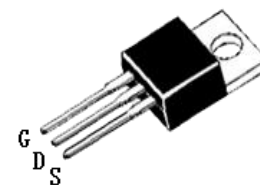

TO-220AB/SL8N65

FEATURES

- Fast Switching
- Low ON Resistance
- Low Gate Charge
- 100% Single Pulse avalanche energy Test

APPLICATIONS

- Power switch circuit of adaptor and charger.

MECHANICAL DATA

- Case: Molded plastic
- Mounting Position: Any
- Molded Plastic: UL Flammability Classification Rating 94V-0
- Lead free in compliance with EU RoHS 2011/65/EU directive
- Solder bath temperature 275°C maximum, 10s per JESD 22-B106

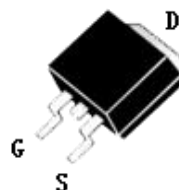

TO-263/SL8N65K

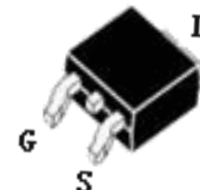

TO-252/SL8N65D

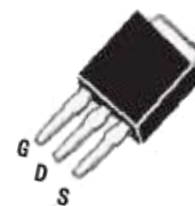

TO-251/SL8N65I

Maximum Ratings at Tc=25°C unless otherwise specified

Characteristics	Symbol	Value			Unit
		220AB/263	220F	251/252	
Drain-Source Voltage	V_{DS}	650			V
Gate-Source Voltage	V_{GS}	±30			V
Continue Drain Current	I_D	8			A
Pulsed Drain Current (Note1)	I_{DM}	28			A
Power Dissipation	P_D	100	30	100	W
Single Pulse Avalanche Energy (Note1)	E_{AS}	350			mJ
Operating Temperature Range	T_J	150			°C
Storage Temperature Range	T_{STG}	-55 to +150			°C
Thermal Resistance, Junction to Case	$R_{\theta JC}$	1.25	3.57	1.25	°C/W
Thermal Resistance, Junction to Ambient	$R_{\theta JA}$	62.5	62.5	100	°C/W

Note1:Pulse test: 300 μ s pulse width, 2 % duty cycle

Electrical Characteristics at Tc=25°C unless otherwise specified

Characteristics	Test Condition	Symbol	Min	Typ	Max	Unit
Drain-Source Breakdown Voltage	$V_{GS} = 0 V, I_D = 250 \mu A$	BV_{DSS}	655	-	-	V
Drain-Source Leakage Current	$V_{DS} = 655 V, V_{GS} = 0 V$	I_{DSS}	-	-	1	μA
Gate Leakage Current	$V_{GS} = \pm 30 V, V_{DS} = 0 V$	I_{GSS}	-	-	±100	nA
Gate-Source Threshold Voltage	$V_{DS} = V_{GS}, I_D = 250 \mu A$	$V_{GS(th)}$	2	-	4	V
Drain-Source On-State Resistance	$V_{GS} = 10 V, I_D = 3.5 A$	$R_{DS(on)}$	-	1.1	1.25	Ω
Forward Transconductance	$V_{DS} = 15 V, I_D = 3.5 A$	gfs	-	6.5	-	S
Input Capacitance	$V_{GS} = 0 V, V_{DS} = 25 V,$ $f = 1 MHz$	C_{iss}	-	981	-	pF
Output Capacitance		C_{oss}	-	85	-	pF
Reverse Transfer Capacitance		C_{rss}	-	4	-	pF
Turn-on Delay Time(Note2)	$I_D = 7 A, V_{DD} = 325 V,$ $R_G = 10 \Omega$	$t_{d(ON)}$	-	18	-	ns
Rise Time(Note2)		t_r	-	19	-	ns
Turn-Off Delay Time(Note2)		$t_{d(OFF)}$	-	39	-	ns
Fall Time(Note2)		t_f	-	18	-	ns
Total Gate Charge(Note2)	$I_D = 7 A, V_{DD} = 520 V,$ $V_{GS} = 10 V$	Q_G	-	18	-	nC
Gate to Source Charge(Note2)		Q_{GS}	-	4.3	-	nC
Gate to Drain Charge(Note2)		Q_{GD}	-	7.6	-	nC

Source-Drain Diode Characteristics at Ta=25°C unless otherwise specified

Characteristics	Test Condition	Symbol	Min.	Typ.	Max.	Unit
Maximun Body-Diode Continuous Current	$T_J = 25^\circ C$	I_S	-	-	8	A
Maximun Body-Diode Pulsed Current(Note2)		I_{SM}	-	-	28	A
Drain-Source Diode Forward Voltage	$I_{SD} = 7 A$	V_{SD}	-	-	1.4	V
Reverse Recovery Time(Note2)	$I_{SD} = 7 A, V_{GS} = 0 V,$ $di_F / dt = 100 A/\mu s$	trr	-	370	-	ns
Reverse Recovery Charge(Note2)		Qrr	-	1.9	-	μC

Note2:Pulse test: 300 μ s pulse width, 2 % duty cycle

RATINGS AND CHARACTERISTIC CURVES

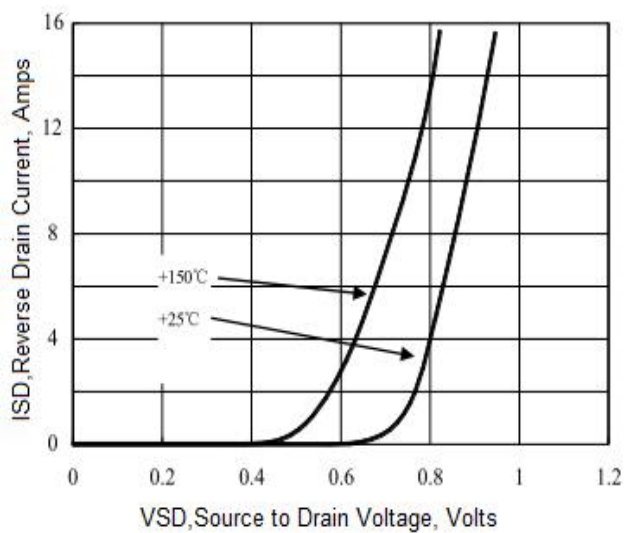
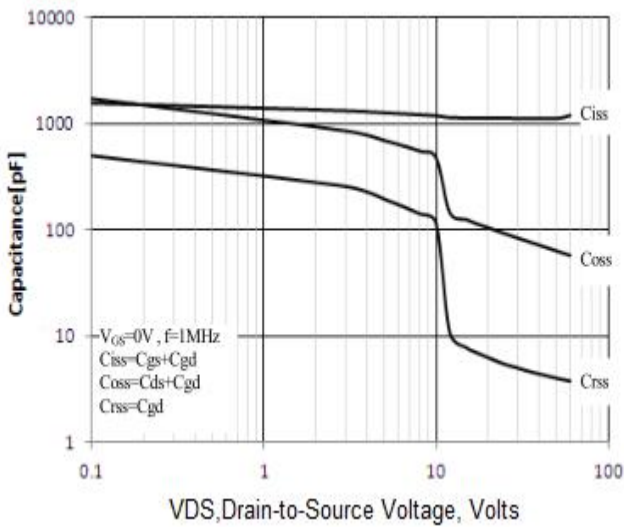
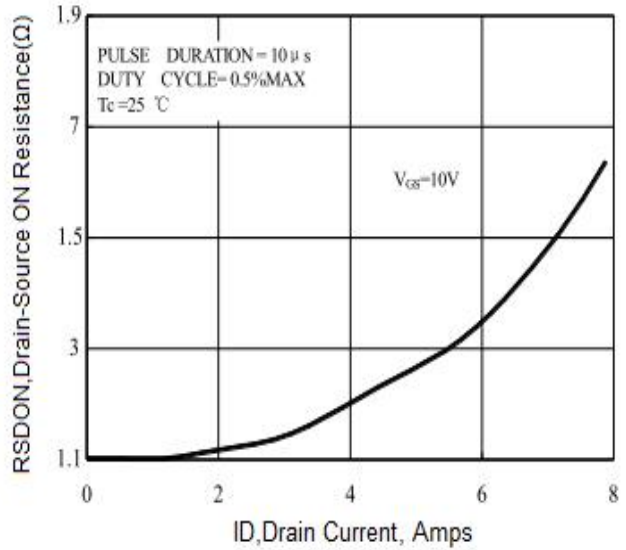
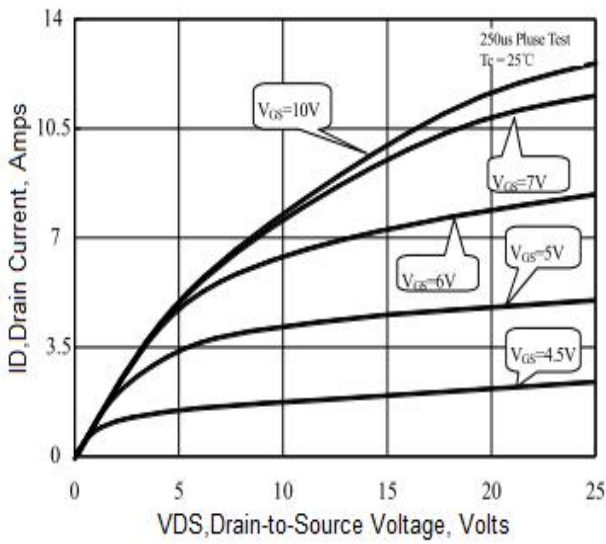
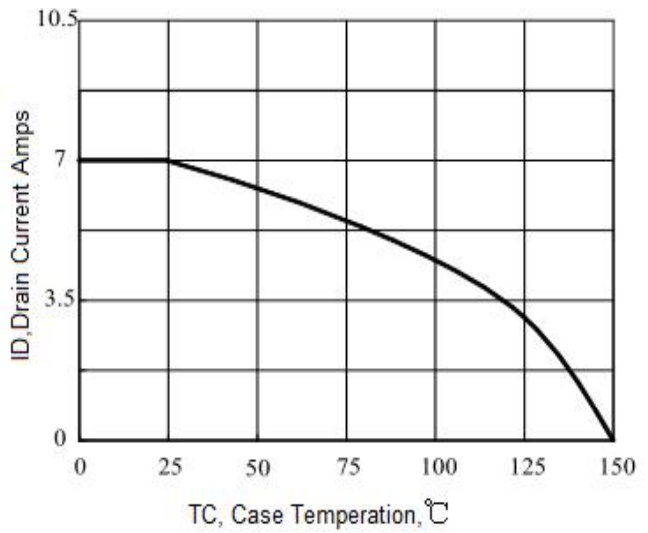
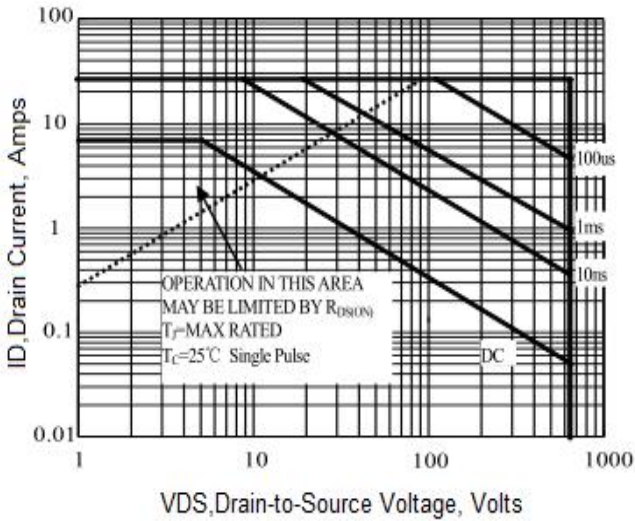

Package Outline Dimensions millimeters

T0-220F

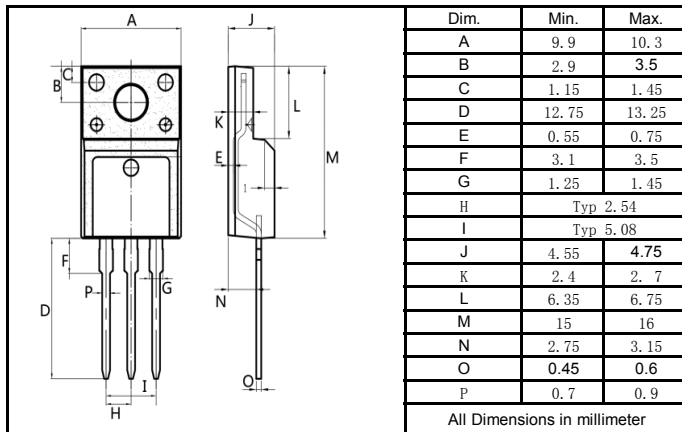

T0-220AB

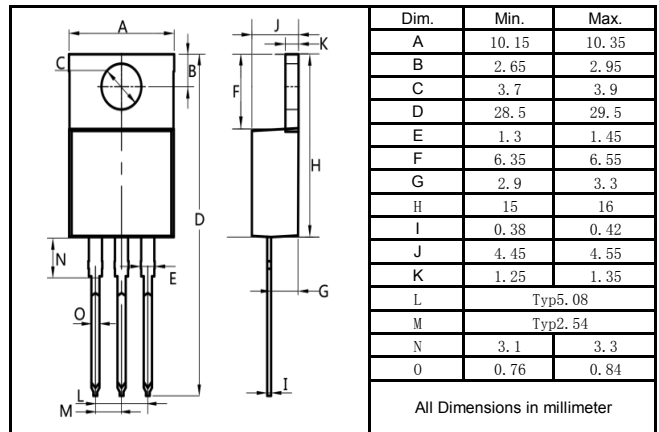

T0-263

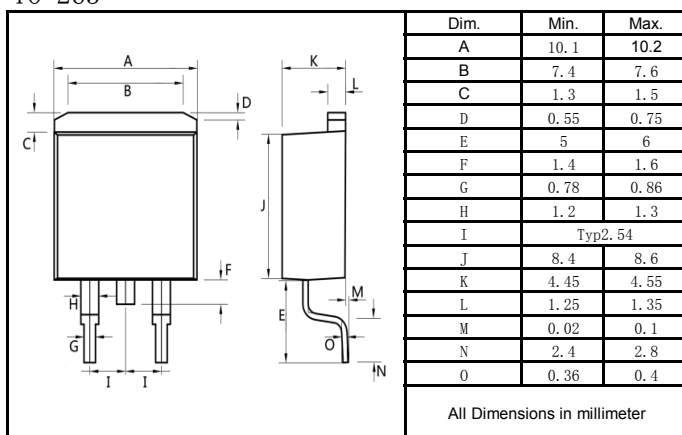

T0-252

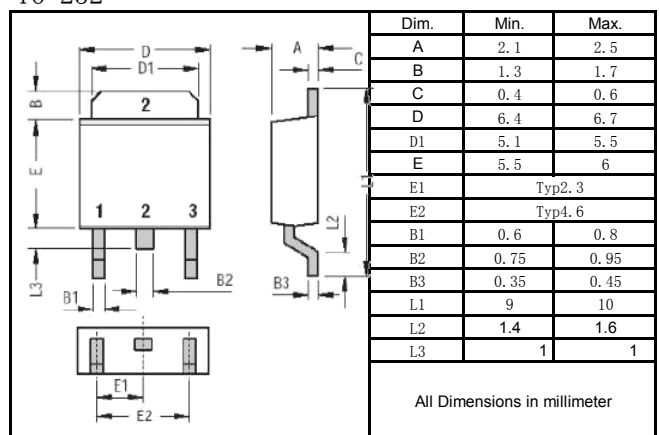

T0-251

